

Gainsborough now offers a broad selection of key in lever lockset designs, from the economical 4200 Series to the heavy duty 4600 Series.

The 4600 Series key in lever locksets offer designs in a variety of functions and finishes. This tubular design allows for quick and easy installation.

- Door Thickness - 35-45mm timber or metal doors
- Keying - 6 pin cylinder
- Backset - 60, 70, 127mm
4200 Series 60/70mm adjustable
- Handing - non-handed to suit left or right-handed doors
- Material - Levers Plated Zinc
Latchbolt Solid Brass



4200 Series

Key in Lever Lockset

SC

🕒 5/10 years



4600/4600DA Series

Key in Lever Lockset

SC

🔒 S2 ⚔ D3

🕒 5/10 years

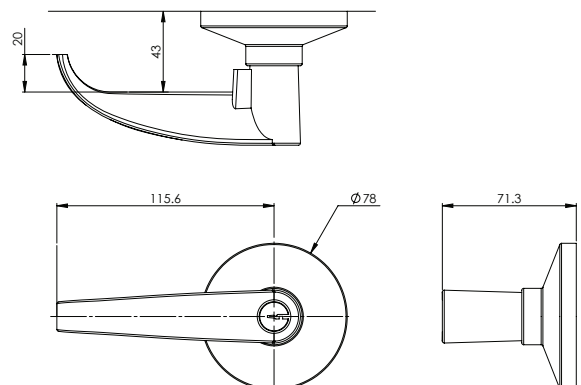

* **Note:** On selected cores for more information on Fire Ratings please contact your Gainsborough representative.

All dimensions in mm ** Only applies to DA Series

Key in Lever Locksets

4200/4600/4600DA Series

GAINSBOROUGH

Architectural HARDWARE

Product Information

Latch

12.7mm throw, fire-rated.
Reversible for right or left-hand doors.
Solid brass latchbolt. Faceplate is self-adjusting to accommodate bevelled or flat doors. Faceplate size: 58mm x 25mm

Strike

70mm x 29mm x 1.5mm standard universal strike. Strike box furnished.

Door Preparation - (non fire door)

54mm (2¹/₈") cross bore
and 25mm (1") edge bore.

Lever Dimensions

4200 Series: Lever length is 118mm, with a projection over 62mm from the face of door.

4600 Series: Lever length is 130mm, curved in design, with a projection over 50mm from the face of door.

4600DA Series: Lever length is 130mm curved in design with a clearance of 43mm from the face of the door. The turnsnib is 45.3mm from the centre at the spindle, refer to diagram below.

Keying Information

6 pin tumbler cylinder supplied in the standard broach, keyed to differ with 2 keys per lock. Special keying is available.

All Gainsborough locksets come with brass keys.

Standard keyed differently (KD) unless otherwise specified. Locks also can be keyed to following systems:

Keying Codes

KA	Keyed Alike
MK	Master Keyed
GMK	Grand Master Keyed
GGMK	Great Grand Master Keyed
MA	Maison Keyed
PK	Project Keyed
PMK	Project Master Keyed

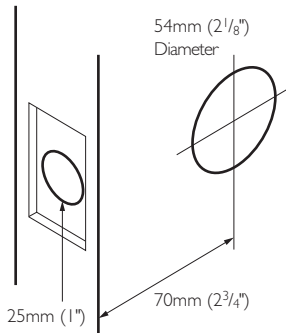

4200 Series Key in Lever Locksets

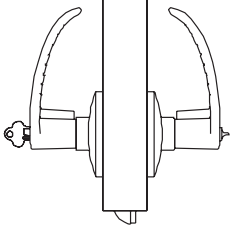
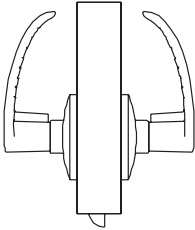
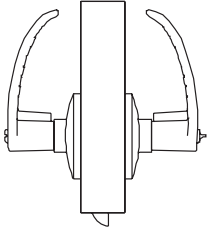
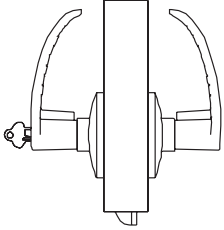
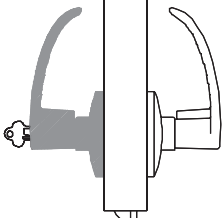
Product	Description	Backset	Catalogue No.
Entrance/Escape Lockset 	<p>Key unlocks outside lever.</p> <p>Turnbutton inside locks and unlocks outside lever. Inside lever remains free at all times.</p> <p>Auxiliary bolt deadlatches latchbolt when door is closed.</p>	60/70mm	4200
Passage Set 	<p>Latchbolt operated by both levers at all times.</p>	60/70mm	4220
Privacy Lockset 	<p>Both levers are locked or unlocked by turnbutton inside.</p> <p>In case of emergency, the outside handle can be unlocked by a coin or screwdriver in the button.</p>	60/70mm	4230
Classroom Lockset 	<p>Outside lever is locked or unlocked by key in outside lever.</p> <p>Inside lever is always free.</p>	60/70mm	4250
Storeroom Escape Lockset 	<p>Key in outside lever retracts latch.</p> <p>Outside lever remains rigid.</p> <p>Inside lever is always free.</p> <p>Auxiliary bolt deadlatches latchbolt when door is closed.</p>	60/70mm	4260

Finish Codes: **SC** Satin Chrome Plate

Note: Add finish code to above to form complete catalogue number e.g. **4230 SC**

4600 Series Key in Lever Locksets

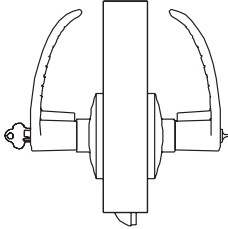
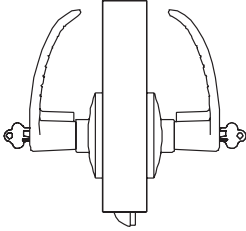
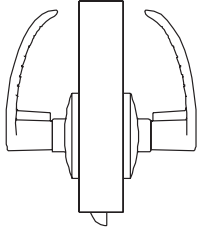
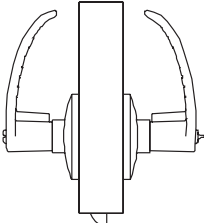
Product	Description	Backset	Catalogue No.
Entrance/Escape Lockset			
	Key unlocks outside lever.	70mm	4600
	Turnbutton inside locks and unlocks outside lever. Inside lever remains free at all times.	60mm	4601
	Auxiliary bolt deadlatches latchbolt when door is closed.	127mm	4602
	Option: Rigid handle when snibbed.	70mm	4603
Glass Door Lockset			
	Double Cylinder.	70mm	4610
	Lock is opened by lever from either side.	60mm	4611
	Key from either side locks or unlocks both levers.	127mm	4612
	Auxiliary bolt deadlatches latchbolt when door is closed.		
Passage Set			
	Latchbolt operated by both levers at all times.	70mm	4620
		60mm	4621
		127mm	4622
Privacy Lockset			
	Both levers are locked or unlocked by turnbutton inside.	70mm	4630
		60mm	4631
	In case of emergency, the outside handle can be unlocked by a coin or screwdriver in the button.	127mm	4632

Finish Codes: **SC** Satin Chrome Plate

Note: Add finish code to above to form complete catalogue number e.g. **4630 SC**

4600 Series Key in Lever Locksets

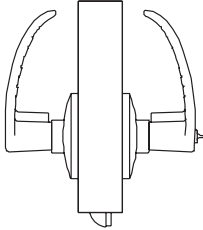
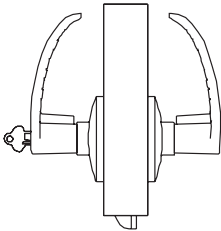
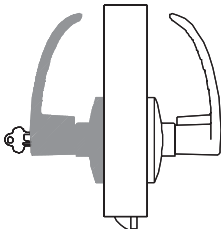
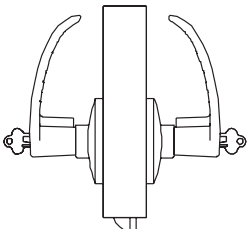
Product	Description	Backset	Catalogue No.
Patio Lockset			
	Both levers are locked or unlocked by turnbutton in the inside lever.	70mm	4640
		60mm	4641
	Auxiliary bolt deadlatches latchbolt when door is closed.	127mm	4642
Classroom Lockset			
	Outside lever is locked or unlocked by key in outside lever.	70mm	4650
		60mm	4651
	Inside lever is always free.	127mm	4652
Storeroom Escape Lockset			
	Key in outside lever retracts latch.	70mm	4660
	Outside lever remains rigid.	60mm	4661
	Inside lever is always free.	127mm	4662
	Auxiliary bolt deadlatches latchbolt when door is closed.		
Communication Lockset			
	Key in outside lever retracts latch.	70mm	4670
	Outside lever remains rigid.	60mm	4671
	Inside lever is always free.	127mm	4672

Finish Codes: **SC** Satin Chrome Plate**Note:** Add finish code to above to form complete catalogue number e.g. **4670 PB**

4600 Series Key in Lever Locksets

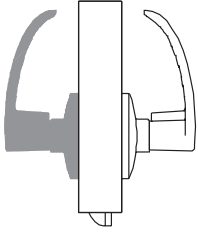
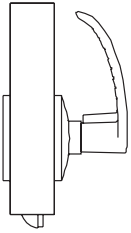
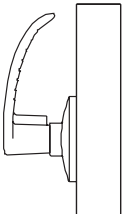
Product	Description	Backset	Catalogue No.
Exterior Escape Lockset			
	Outside lever remains rigid.	70mm	4680
		60mm	4681
		127mm	4682
Exterior Escape Half Set			
	Latchbolt operated by inside lever.	70mm	4690
	Blank plate outside.	60mm	4691
		127mm	4692
Dummy Trim			
	Single dummy trim for one side of door.	70mm	465D

Finish Codes: **SC** Satin Chrome Plate

Note: Add finish code to above to form complete catalogue number e.g. **4690 CP**

4600DA Series Key in Lever Locksets

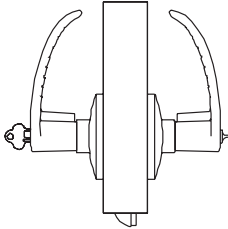
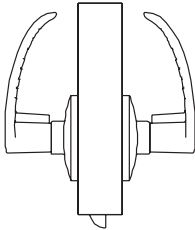
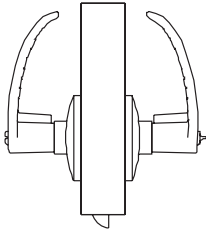
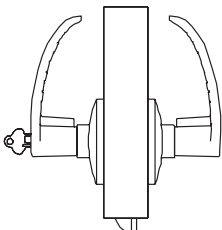
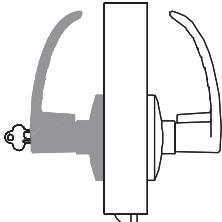
Product	Description	Backset	Catalogue No.
Entrance/Escape Lockset			
	Key unlocks outside lever.	70mm	4600DA
	Turnbutton inside locks and unlocks outside lever. Inside lever remains free at all times.	60mm	4601DA
	Auxiliary bolt deadlatches latchbolt when door is closed.	127mm	4602DA
Option: Rigid handle when snibbed.			
Passage Set			
	Latchbolt operated by both levers at all times.	70mm	4620DA
		60mm	4621DA
		127mm	4622DA
Privacy Lockset			
	Both levers are locked or unlocked by turnbutton inside.	70mm	4630DA
		60mm	4631DA
	In case of emergency, the outside handle can be unlocked by a coin or screwdriver in the button.	127mm	4632DA
Classroom Lockset			
	Outside lever is locked or unlocked by key in outside lever.	70mm	4650DA
		60mm	4651DA
	Inside lever is always free.	127mm	4652DA
Storeroom Escape Lockset			
	Key in outside lever retracts latch.	70mm	4660DA
	Outside lever remains rigid.	60mm	4661DA
	Inside lever is always free.	127mm	4662DA
Auxiliary bolt deadlatches latchbolt when door is closed.			

Finish Codes: SC Satin Chrome Plate**Note:** Add finish code to above to form complete catalogue number e.g. **4630 SC**

Accessories

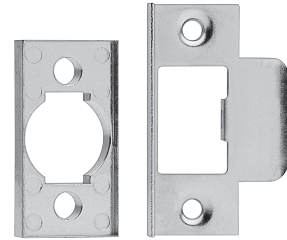

Latches

All 4600 Series latches have solid brass latchbolt with 12.7mm throw.
All latches feature a faceplate size of 58mm x 29mm.

CP SC

To order individual latches, refer catalogue numbers below.

Catalogue No.

- 4500/DL00: 70mm Deadlatch Split Hub
- 4500/PL00: 70mm Privacy/Passage Latch
- 4500/DL01: 60mm Deadlatch Split Hub
- 4500/PL01: 60mm Privacy/Passage Latch
- 4500/DL02: 127mm Deadlatch Split Hub
- 4500/DL03: 70mm Deadlatch One Piece Hub
- 4500/DL04: 60mm Deadlatch One Piece Hub
- 4500/DL05: 127mm One Piece Hub
- 4200/DL01SC: 4200 Spare Latch

Strike Plate

Strikes are reversible for right or left-hand doors.

To order strike plate, refer catalogue number below.

Catalogue No.

4000/SP01

Rebated Conversion Set

For Leversets. Strike plate supplied.

CP SC

Catalogue No

4000/REB